



# Illustrated Parts List

## Model Series

# 21A900

TYPE NUMBERS  
0101 through 0199.

### TABLE OF CONTENTS

Air Cleaner .....	7
Alternator .....	10
Blower Housing .....	7
Camshaft .....	3
Carburetor .....	5, 6
Controls .....	9
Crankshaft .....	3
Cylinder .....	2
Cylinder Head .....	4
Electric Starter .....	8
Engine Sump .....	2
Exhaust System .....	7
Flywheel .....	8
Fuel Supply .....	9
Gasket Set - Engine .....	4
Gasket Set - Valve .....	4
Governor Spring .....	9
Ignition .....	9
Intake Manifold .....	4
Kit - Carburetor Overhaul .....	5
Lubrication .....	3
Operator's Manual .....	2
Piston, Rings, Connecting Rod .....	3
Rewind Starter .....	8
Valves .....	4
Warning Label .....	2

PRINTED IN U.S.A.



COPYRIGHT by BRIGGS & STRATTON CORPORATION  
All rights reserved. No part of this material may be reproduced or transmitted, in any form or by any means, electronic or mechanical, including photocopying, recording or by any information storage and retrieval system, without permission in writing from Briggs & Stratton Corporation.

1058 OPERATOR'S MANUAL

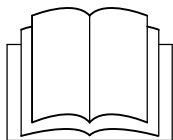

1319 WARNING LABEL

<b>WARNING</b>	
	Read and follow Operating Instructions before running engine.
	Gasoline is flammable. Allow engine to cool at least 2 minutes before refueling.
	Engines emit carbon monoxide, <b>DO NOT</b> run in enclosed area.
	Muffler area temperature may exceed 150°F. Do not touch hot parts.

**REQUIRED** when replacing parts with warning labels affixed.

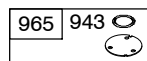
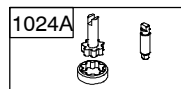
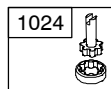
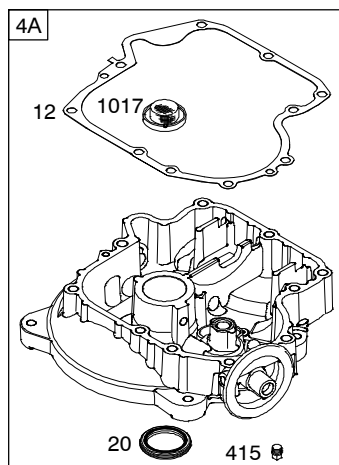
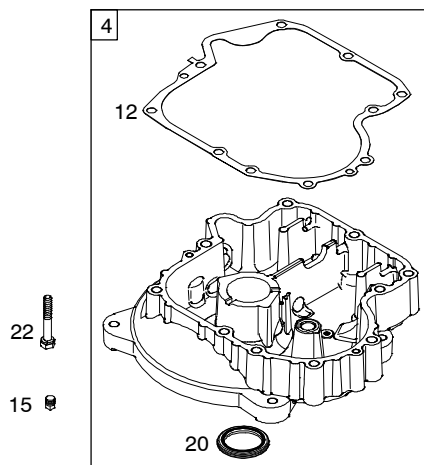
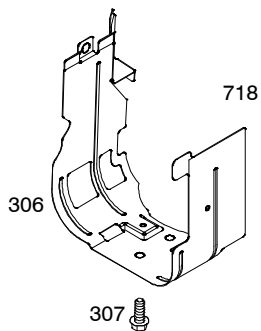
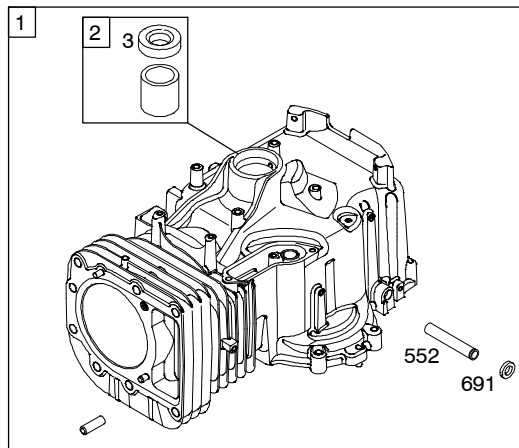

750

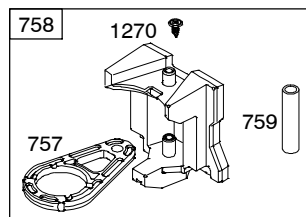
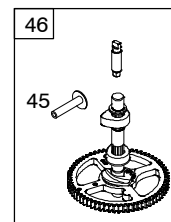
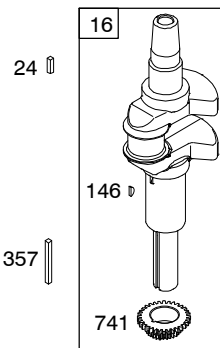
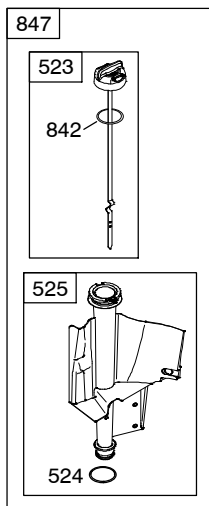
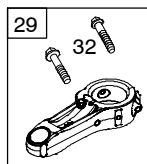
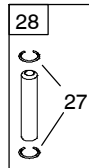
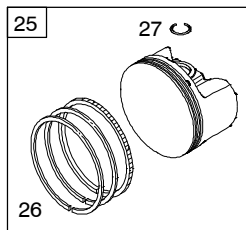

Illustrations cover a range of engines. Parts shown without corresponding text may not be used on your specific engine.  
 5069-3 Assemblies include all parts shown in frames. 06/17/2008

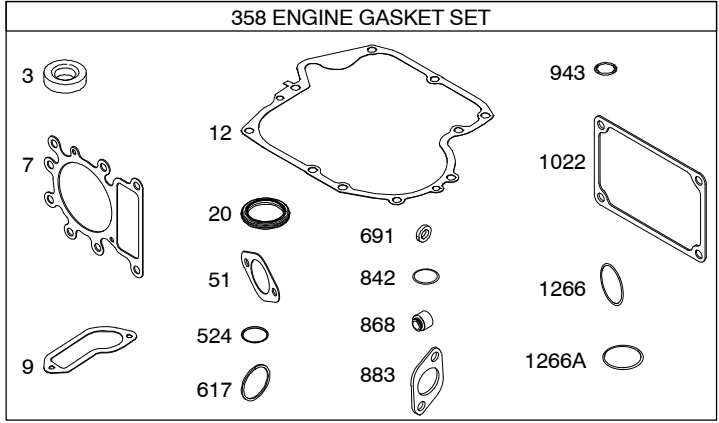
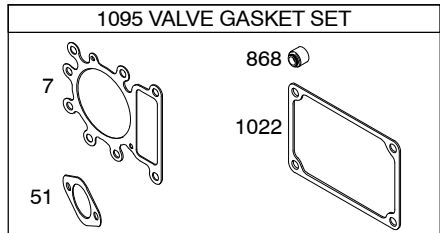
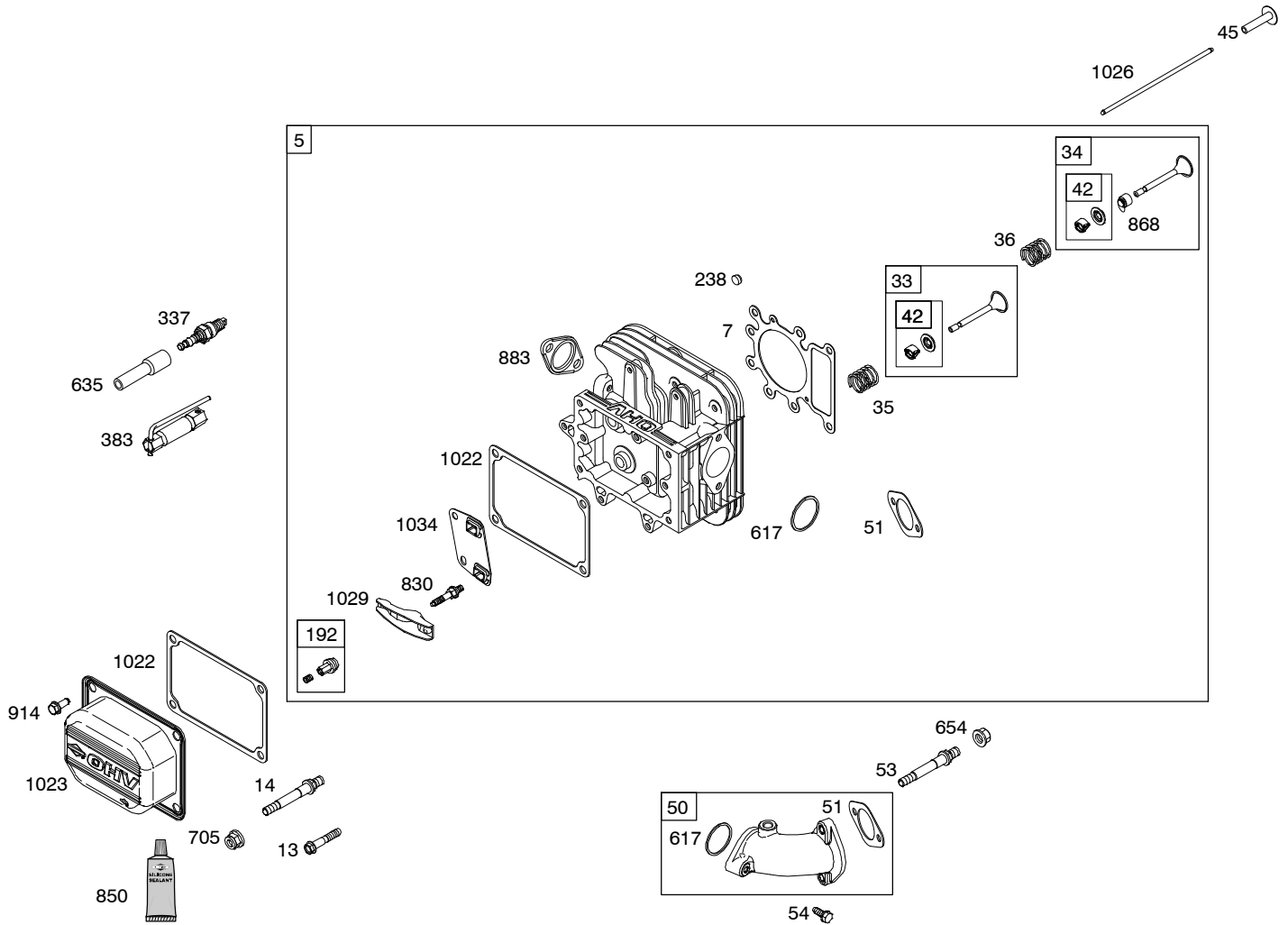

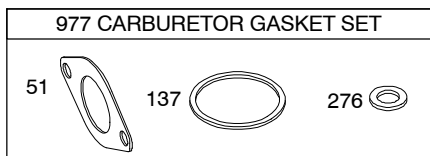
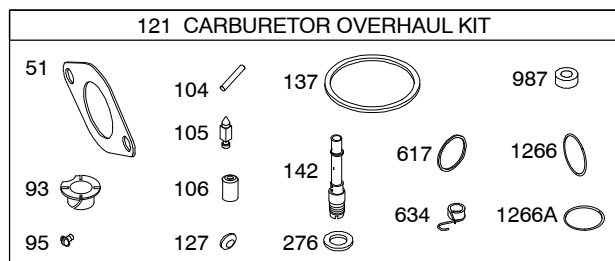
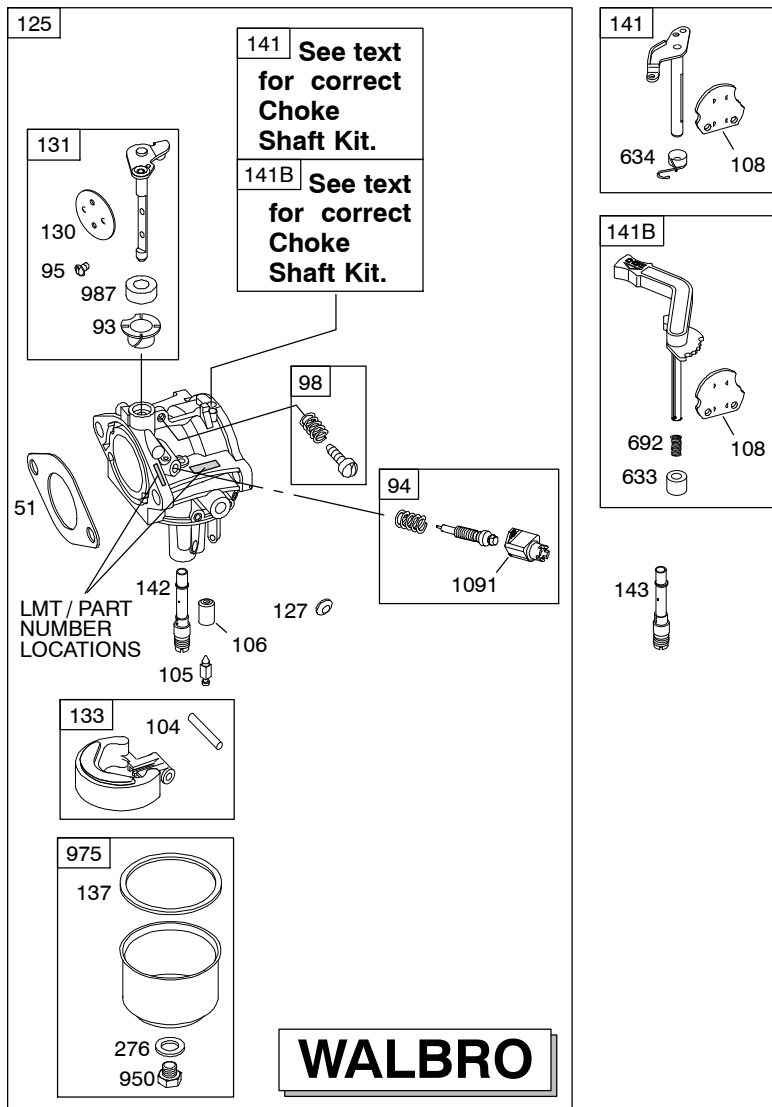

Illustrations cover a range of engines. Parts shown without corresponding text may not be used on your specific engine.

# 21A900

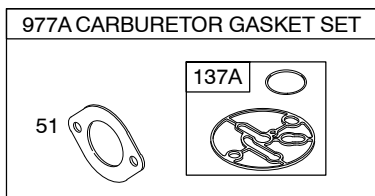
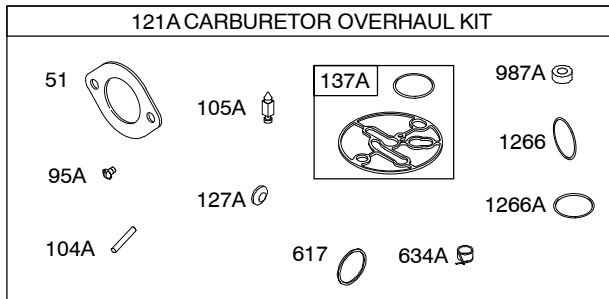
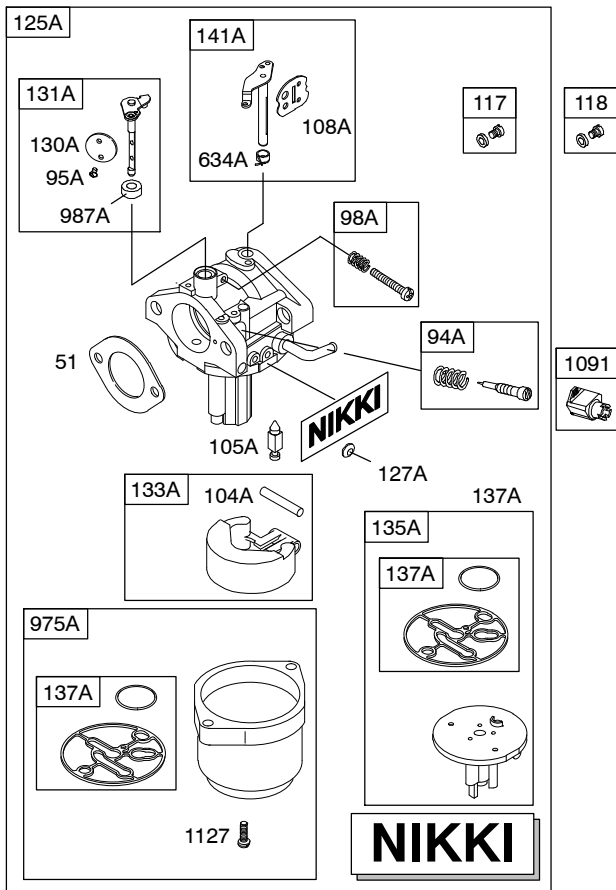

1036 EMISSIONS LABEL

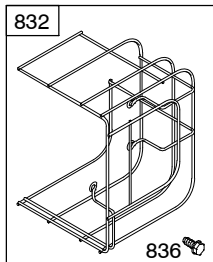
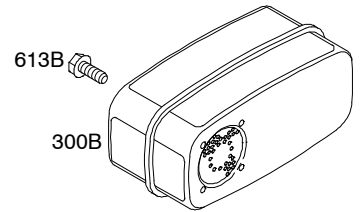
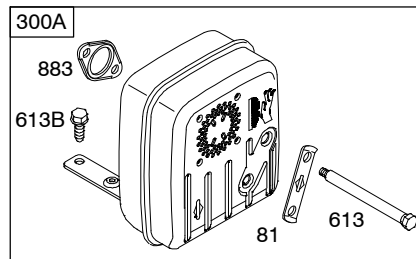
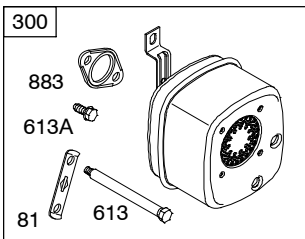
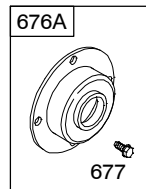
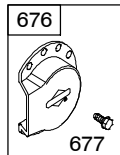
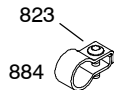
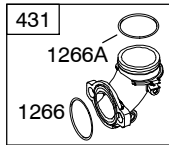
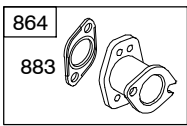
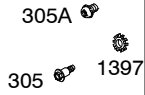
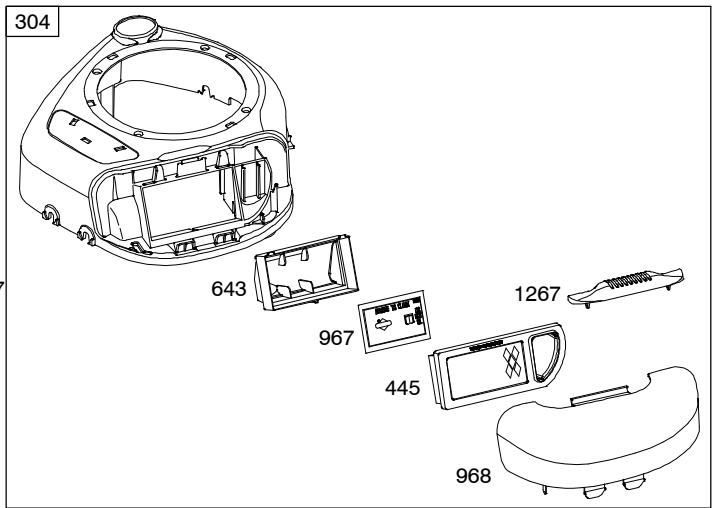
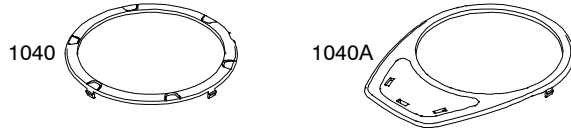

Illustrations cover a range of engines. Parts shown without corresponding text may not be used on your specific engine.  
5069-7 Assemblies include all parts shown in frames. 06/17/2008

# 21A900

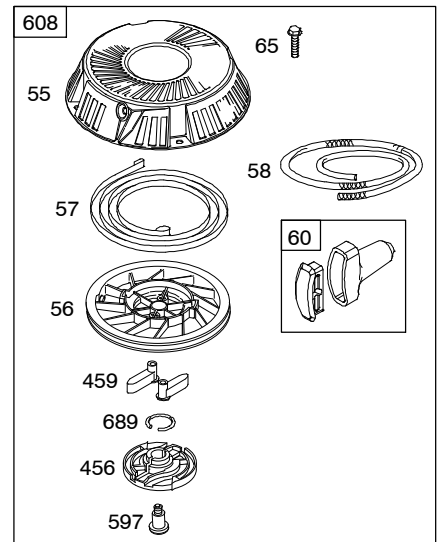
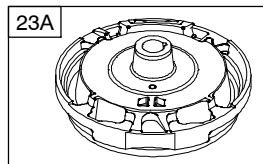
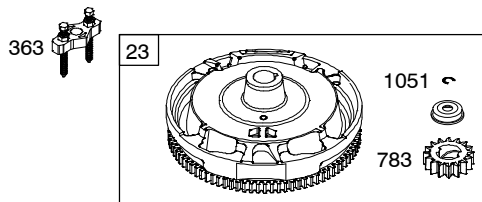
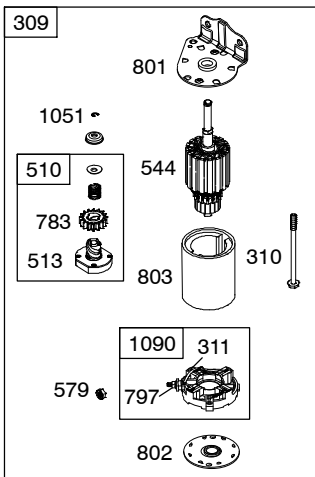
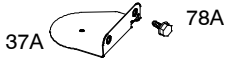
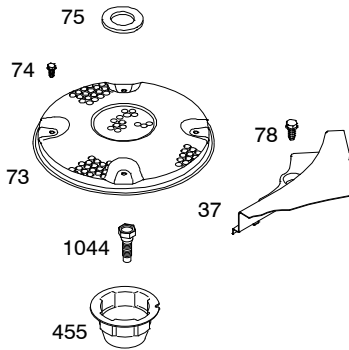
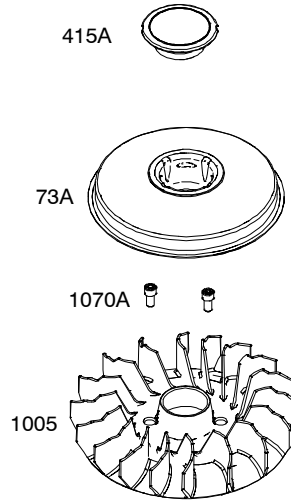
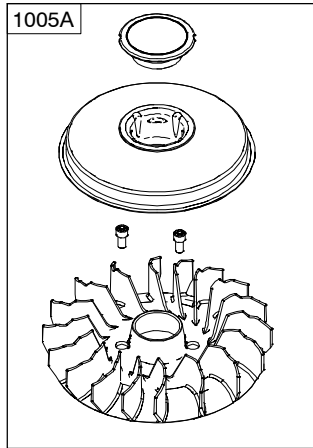
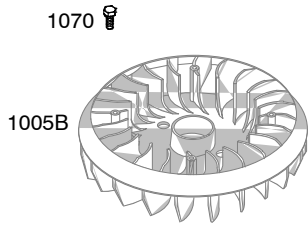



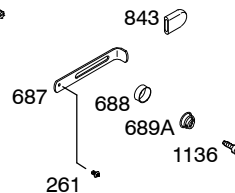
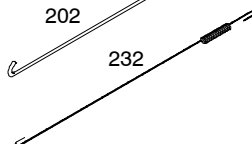
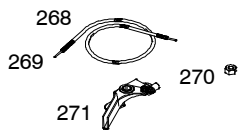
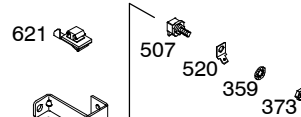
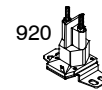
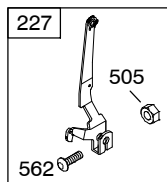
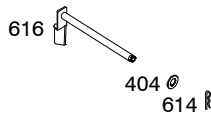
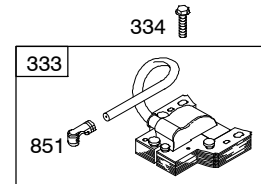
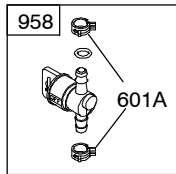
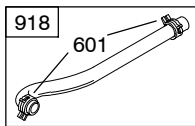
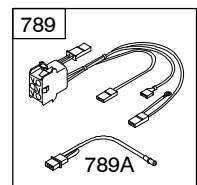
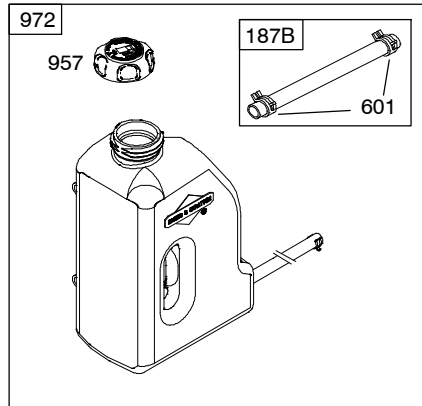
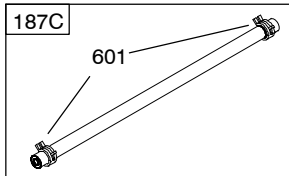
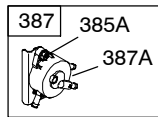
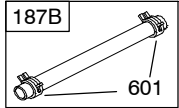
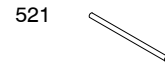
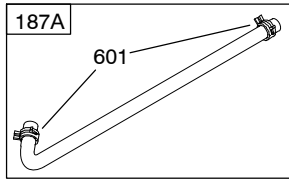
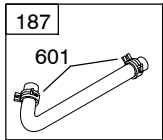



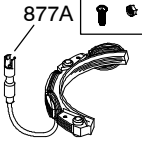
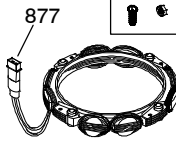
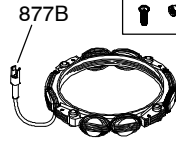
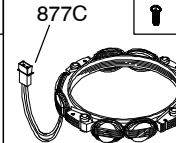
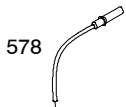

Illustrations cover a range of engines. Parts shown without corresponding text may not be used on your specific engine.

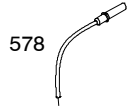
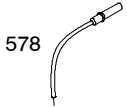
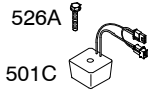
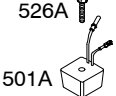
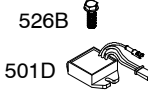
# 21A900

DC ONLY		DUAL CIRCUIT		5 – 9 AMP		10 – 16 AMP	
474A	1059	474B	1059	474C	1059	474D	1059
							
							
							

**NOTE:** All stators use a No. 1119 mounting screw. 

**NOTE:** The proper flywheel part number and/or the alternator magnet size will determine the alternator type or output. See repair instruction manual for additional information.

526B   
501B 

# 21A900

REF. NO.	PART NO.	DESCRIPTION	REF. NO.	PART NO.	DESCRIPTION	REF. NO.	PART NO.	DESCRIPTION
1	697377	Cylinder Assembly	11	794683	Tube-Breather (Used After Code Date 07071800).	23A	693555	Flywheel (Rewind Starter) Used on Type No(s). 0117, 0134, 0139, 0141, 0142, 0149, 0151, 0161, 0166, 0168, 0170, 0171, 0184, 0188, 0190.
2	399265	Kit-Bushing/Seal (Magneto Side)			----- <b>Note</b> -----			
3	★391086S	Seal-Oil (Magneto Side)			697113 Tube-Breather (Used Before Code Date 07071900).			
4	697106	Sump-Engine (Used After Code Date 05100200). ----- <b>Note</b> ----- 795940 Sump-Engine (Used Before Code Date 05100200). Must Use Kit 795940, Includes Sump And Counterweight.	12	★697110	Gasket-Crankcase (.015" Thick) (Standard)			----- <b>Note</b> ----- 698283 Flywheel (Rewind Starter) Used on Type No(s). 0127, 0134, 0136, 0138, 0144.
4A	697188	Sump-Engine (Used After Code Date 05100200). Used on Type No(s). 0101, 0105, 0115, 0119, 0121, 0122, 0129, 0156, 0157, 0165, 0172, 0173, 0176, 0178, 0179, 0180, 0186, 0187, 0188, 0189, 0190, 0191, 0192, 0195, 0197, 0198, 0199. ----- <b>Note</b> ----- 795957 Sump-Engine (Used Before Code Date 05100200). Used on Type No(s). 0101, 0105, 0115, 0119, 0121, 0122, 0129, 0156, 0157, 0165, 0172, 0173, 0176, 0178, 0179, 0180, 0186, 0187, 0188, 0189, 0190, 0191, 0192, 0195, 0197, 0198, 0199. Must Use Kit 795957, Includes Sump And Counterweight.	13	690360	Screw (Cylinder Head)	24	222698S	Key-Flywheel
			14	790560	Stud (Cylinder Head)	25	792305	Piston Assembly (Standard) ----- <b>Note</b> ----- 792728 Piston Assembly (.020" Oversize)
			15	690946	Plug-Oil Drain (3/8" Standard)	26	792306	Ring Set (Standard) ----- <b>Note</b> ----- 792643 Ring Set (.020" Oversize)
			16A	697390	Crankshaft			
			20	★791892	Seal-Oil (PTO Side)	27	698469	Lock-Piston Pin (Used After Code Date 02100300). ----- <b>Note</b> ----- 698138 Lock-Piston Pin (Used Before Code Date 02100400).
			22	692125	Screw (Crankcase Cover/Sump)	28	697099	Pin-Piston
			23	693556	Flywheel Used on Type No(s). 0115, 0137, 0157, 0192. ----- <b>Note</b> ----- 693557 Flywheel Used on Type No(s). 0145, 0147, 0150, 0159, 0176, 0191. 698281 Flywheel Used on Type No(s). 0101, 0104, 0105, 0119, 0120, 0121, 0122, 0123, 0124, 0125, 0128, 0129, 0131, 0140, 0143, 0152, 0153, 0155, 0158, 0162, 0164, 0169, 0172, 0173, 0178, 0183, 0185, 0186, 0187. 698282 Flywheel Used on Type No(s). 0113, 0133, 0154, 0156, 0165, 0167, 0179, 0180, 0189, 0195, 0197, 0198, 0199. 790924 Flywheel Used on Type No(s). 0113, 0156, 0167.	29	791633	Rod-Connecting (Standard) ----- <b>Note</b> ----- 697262 Rod- Connecting (.020" Undersize) (Used Before Code Date 05040400).
						32	791118	Screw (Connecting Rod)
						33	695760	Valve-Exhaust
						34	695761	Valve-Intake
						35	691279	Spring-Valve (Intake)
5	792964	Head-Cylinder						
7	★△273280S	Gasket-Cylinder Head						
9	★697109	Gasket-Breather (Used Before Code Date 07071900). (After Date Code Use Liquid Sealant Reference 850)						
10	697157	Screw (Breather Assembly)						

★ Included in Engine Gasket Set-Ref. No. 358.

● Included in Carburetor Overhaul Kit-Ref. No. 121 or 121A.

◆ Included in Carburetor Gasket Set-Ref. No. 977 or 977A.

△ Included in Valve Gasket Set-Ref. No. 1095.

**Illustrations cover a range of engines. Parts shown without corresponding text may not be used on your specific engine.**

# 21A900

REF. NO.	PART NO.	DESCRIPTION	REF. NO.	PART NO.	DESCRIPTION	REF. NO.	PART NO.	DESCRIPTION
36	691279	Spring-Valve (Exhaust)	78	691003	Screw (Flywheel Guard)	121	790031	Kit-Carburetor Overhaul (Walbro)
37	697352	Guard-Flywheel	78A	690364	Screw (Flywheel Guard)(Electric Start)	121A	698787	Kit-Carburetor Overhaul (Nikki)
37A	697626	Guard-Flywheel (Electric Start) Used on Type No(s). 0117, 0127, 0134, 0136, 0138, 0139, 0141, 0142, 0144, 0149, 0151, 0161, 0166, 0168, 0170, 0171, 0176, 0184, 0188, 0190.	81	691178	Lock-Muffler Screw	125	790021	Carburetor (Walbro) (Used Before Code Date 06121900). Used on Type No(s). 0142, 0166.
42	499586	Keeper-Valve	93	690602	Bushing-Throttle Shaft	125A	791266	Carburetor (Nikki) (Used Before Code Date 07122600).
43	691968	Slinger-Governor/Oil	94	498030	Kit-Idle Mixture (Walbro)			----- <b>Note</b> -----
45	690564	Tappet-Valve	94A	695425	Kit-Idle Mixture (Nikki)			<b>794653</b> Carburetor (Nikki) (Used After Code Date 07122500).
46	793880	Camshaft	95	691636	Screw (Throttle Valve) (Walbro)	125B	794215	Carburetor (Nikki) (Used Before Code Date 07122600).
50	697361	Manifold-Intake	95A	690718	Screw (Throttle Valve)(Nikki)			----- <b>Note</b> -----
51★◆△	692137	Gasket-Intake	98	495800	Kit-Idle Speed (Walbro)			<b>794653</b> Carburetor (Nikki) (Used After Code Date 07122500).
53	690227	Stud (Carburetor)	98A	695408	Kit-Idle Speed (Nikki)			
54	691148	Screw (Intake Manifold)	104	690525	Pin-Float Hinge (Walbro)			
55	695130	Housing-Rewind Starter	104A	694918	Pin-Float Hinge (Nikki)			
56	695129	Pulley-Starter	105	231855S	Valve-Float Needle (Walbro)			----- <b>Note</b> -----
57	695131	Spring-Rewind Starter	105A	696136	Valve-Float Needle (Nikki)			<b>794653</b> Carburetor (Nikki) (Used After Code Date 07122500).
58	695132	Rope-Starter	106	690577	Seat-Inlet (Walbro)(Gravity Feed)	127	694524	Plug-Welch
60	494212	Grip-Starter Rope			----- <b>Note</b> -----	127A	690727	Plug-Welch (Nikki)
65	690759	Screw (Rewind Starter) (Used After Code Date 07040800).	108	691227	Valve-Choke (Walbro)	130	790024	Valve-Throttle (Walbro)
		----- <b>Note</b> -----	108A	698773	Valve-Choke (Nikki)	130A	698774	Valve-Throttle (Nikki)
		<b>697725</b> Screw (Rewind Starter) (Used Before Code Date 07040900).	117	699897	Jet-Main (Standard) (Used Before Code Date 07122600).	131	790901	Kit-Throttle Shaft (Walbro)
73		Screen-Rotating (Service With Flywheel Fan 794440) (Used Before Code Date 07040900).			----- <b>Note</b> -----	131A	698776	Kit-Throttle Shaft (Nikki)
73A	794437	Screen-Rotating (Used After Code Date 07040800).	118	699898	Jet-Main (High Altitude) (Used Before Code Date 07122600).	133	494381	Float-Carburetor (Walbro)
74	697897	Screw (Rotating Screen) (Used Before Code Date 07040900).			----- <b>Note</b> -----	133A	694914	Float-Carburetor (Nikki)
75	690582	Washer (Flywheel)			<b>791405</b> Jet Main (High Altitude) (Used After Code Date 07122500).	135A	698780	Tube-Fuel Transfer (Nikki) (Used Before Code Date 07122600).
75	690582	Washer (Flywheel)			----- <b>Note</b> -----			<b>792022</b> Tube-Fuel Transfer (Nikki) (Used After Code Date 07122500).

★ Included in Engine Gasket Set-Ref. No. 358.

● Included in Carburetor Overhaul Kit-Ref. No. 121 or 121A.

◆ Included in Carburetor Gasket Set-Ref. No. 977 or 977A.

△ Included in Valve Gasket Set-Ref. No. 1095.

**Illustrations cover a range of engines. Parts shown without corresponding text may not be used on your specific engine.**

# 21A900

REF. NO.	PART NO.	DESCRIPTION	REF. NO.	PART NO.	DESCRIPTION	REF. NO.	PART NO.	DESCRIPTION
	<b>137</b> ◆◆ <b>281165S</b>	Gasket-Float Bowl (Walbro)	<b>192</b>	<b>691986</b>	Adjuster-Rocker Arm	<b>216</b>	<b>691840</b>	Link-Choke
<b>137A</b>	◆◆ <b>698781</b>	Gasket-Float Bowl (Nikki)	<b>202</b>	<b>691841</b>	Link-Mechanical Governor	<b>222</b>	<b>694042</b>	Bracket-Control
<b>141</b>	<b>790902</b>	Kit-Choke Shaft (Walbro)	<b>209</b>	<b>792813</b>	Spring-Governor (Brown) Used on Type No(s). 0115, 0117, 0119, 0120, 0121, 0122, 0124, 0127, 0128, 0129, 0131, 0134, 0136, 0138, 0139, 0140, 0141, 0142, 0143, 0144, 0145, 0147, 0149, 0153, 0154, 0159, 0161, 0162, 0164, 0165, 0166, 0168, 0170, 0172, 0173, 0176, 0178, 0180, 0183, 0184, 0185, 0186, 0187, 0188, 0189, 0190, 0191, 0192, 0197, 0198, 0199.	<b>227</b>	<b>691374</b>	Lever-Governor Control
<b>141A</b>	<b>698778</b>	Kit-Choke Shaft (Nikki)				<b>232</b>	<b>691842</b>	Spring-Governor Link
<b>141B</b>	<b>790903</b>	Kit-Choke Shaft (Walbro) Used on Type No(s). 0142, 0166.				<b>238</b>	<b>691843</b>	Cap-Valve
<b>141C</b>	<b>793386</b>	Kit-Choke Shaft (Manual Choke)				<b>239</b>	<b>491657S</b>	Switch-Oil Pressure Used on Type No(s). 0115, 0188.
<b>142</b>	◆ <b>790025</b>	Nozzle-Carburetor (Standard)(Walbro)				<b>240</b>	<b>298090S</b>	Filter-Fuel (Red, 150 Microns) Used on Type No(s). 0129.
<b>143</b>	<b>790028</b>	Nozzle-Carburetor (High Altitude)(Walbro)						----- <b>Note</b> -----
<b>146</b>	<b>691639</b>	Key-Timing						<b>394358S</b> Filter-Fuel (White, 75 Microns) Used on Type No(s). 0101, 0104, 0105, 0113, 0117, 0119, 0120, 0123, 0124, 0125, 0127, 0128, 0131, 0134, 0136, 0138, 0146, 0152, 0155, 0156, 0158, 0167, 0168, 0169, 0171, 0172, 0176, 0180, 0183, 0184, 0186, 0192, 0198.
<b>187</b>	<b>791805</b>	Line-Fuel (Formed)(10-1/4 Inches Long)(Cut to Required Length)						
<b>187A</b>	<b>791806</b>	Line-Fuel (Formed)(21" Long)(Cut To Required Length)						
<b>187B</b>	<b>791766</b>	Line-Fuel (15" Long)(Cut To Required Length)				<b>240A</b>	<b>691035</b>	Filter-Fuel (Clear, 40 Microns) Used on Type No(s). 0115, 0121, 0122, 0133, 0137, 0139, 0140, 0141, 0142, 0143, 0144, 0145, 0147, 0149, 0150, 0151, 0153, 0154, 0157, 0159, 0161, 0162, 0164, 0165, 0166, 0170, 0173, 0178, 0179, 0185, 0187, 0188, 0189, 0190, 0191, 0195, 0197, 0199.
<b>187C</b>	<b>791745</b>	Line-Fuel (23 Inches Long)(Cut To Required Length)						
<b>188</b>	<b>691693</b>	Screw (Control Bracket)				<b>261</b>	<b>697176</b>	Screw (Control Slide) Used on Type No(s). 0139, 0140, 0142, 0166.

★ Included in Engine Gasket Set-Ref. No. 358.

● Included in Carburetor Overhaul Kit-Ref. No. 121 or 121A.

◆ Included in Carburetor Gasket Set-Ref. No. 977 or 977A.

△ Included in Valve Gasket Set-Ref. No. 1095.

**Illustrations cover a range of engines. Parts shown without corresponding text may not be used on your specific engine.**

# 21A900

REF. NO.	PART NO.	DESCRIPTION	REF. NO.	PART NO.	DESCRIPTION	REF. NO.	PART NO.	DESCRIPTION
265	691024	Clamp-Casing	311	497608	Brush Set	387A	808656	Pump-Fuel
267	794904	Screw (Casing Clamp)	333	795315	Armature-Magneto	404	691691	Washer (Governor Crank)
268	691025	Casing-Control Wire (Cut To Required Length)	334	691061	Screw (Magneto Armature)	415	690283	Plug (Sump)
269	691026	Wire-Control (Cut To Required Length)	337	491055S	Plug-Spark ----- <b>Note</b> ----- <b>691043</b> Plug-Spark Used on Type No(s). 0104, 0105, 0113, 0121, 0122, 0131, 0146, 0147, 0149, 0150, 0151, 0152, 0155, 0156, 0157, 0158, 0167, 0169, 0171, 0172, 0173, 0178, 0179, 0183, 0186.	415	794129	Plug (Cover/Retainer) (Used After Code Date 07040800).
270	691027	Nut (Control Wire Casing)	356	697397	Wire-Stop	431	697122	Elbow-Intake
271	691028	Lever-Control	356A	398808	Wire-Stop	445	698413	Filter-Air Cleaner Cartridge (Non Washable)
276	◆692255	Washer-Sealing	356B	697089	Wire-Stop	455	695113	Cup-Flywheel Used on Type No(s). 0101, 0105, 0115, 0117, 0119, 0123, 0124, 0125, 0127, 0128, 0134, 0136, 0138, 0139, 0141, 0142, 0144, 0145, 0147, 0149, 0150, 0151, 0153, 0157, 0159, 0161, 0162, 0166, 0168, 0170, 0171, 0176, 0179, 0184, 0185, 0187, 0188, 0190, 0191.
300	697048	Muffler Used on Type No(s). 0117, 0119, 0120, 0129, 0134, 0139, 0140, 0141, 0143, 0144, 0145, 0146, 0147, 0149, 0150, 0151, 0153, 0154, 0159, 0161, 0162, 0166, 0168, 0172, 0176, 0178, 0180, 0184, 0185, 0186, 0187, 0188, 0190, 0191, 0192, 0195, 0198, 0199.	356C	399222	Wire-Stop	456	695128	Plate-Pawl Friction
300A	697349	Muffler Used on Type No(s). 0115, 0133, 0136, 0137, 0138, 0142, 0143, 0157, 0164, 0165, 0170, 0171, 0179.	357	691483	Key-Drive Pulley Used on Type No(s). 0156, 0171.	459	281505S	Pawl-Ratchet
300B	498984S	Muffler Used on Type No(s). 0121, 0122, 0173.	358	697151	Gasket Set-Engine	474A	696578	Alternator (DC Only) Used on Type No(s). 0140, 0143, 0145, 0162, 0164.
304	698473	Housing-Blower (Black) ----- <b>Note</b> ----- <b>699085</b> Housing- Blower (Red)	373	691612	Nut (Ground Terminal)	474B	696459	Alternator (Dual Circuit) Used on Type No(s). 0101, 0104, 0105, 0119, 0120, 0121, 0122, 0123, 0124, 0125, 0128, 0131, 0147, 0150, 0152, 0153, 0155, 0158, 0159, 0169, 0172, 0173, 0178, 0183, 0185, 0186, 0187, 0191.
305	697102	Screw (Blower Housing)	383	89838S	Wrench-Spark Plug			
305A	697103	Screw (Blower Housing)	385	694476	Screw (Fuel Pump)			
306	697359	Shield-Cylinder	385A	690297	Screw (Fuel Pump)			
307	691003	Screw (Cylinder Shield)	387	697090	Pump-Fuel (Includes Mounting Bracket) Used on Type No(s). 0115, 0121, 0122, 0133, 0137, 0139, 0140, 0141, 0142, 0143, 0144, 0145, 0147, 0149, 0150, 0151, 0153, 0154, 0157, 0159, 0161, 0162, 0164, 0165, 0166, 0170, 0172, 0173, 0178, 0179, 0185, 0186, 0187, 0188, 0189, 0190, 0191, 0195, 0197, 0199.			
309	693551	Motor-Starter						
310	690323	Screw (Starter Motor)						

★ Included in Engine Gasket Set-Ref. No. 358.

● Included in Carburetor Overhaul Kit-Ref. No. 121 or 121A.

◆ Included in Carburetor Gasket Set-Ref. No. 977 or 977A.

▲ Included in Valve Gasket Set-Ref. No. 1095.

**Illustrations cover a range of engines. Parts shown without corresponding text may not be used on your specific engine.**

REF. NO.	PART NO.	DESCRIPTION	REF. NO.	PART NO.	DESCRIPTION	REF. NO.	PART NO.	DESCRIPTION
474C	696457	Alternator (5 To 9 Amp Regulated) Used on Type No(s). 0113, 0129, 0133, 0137, 0146, 0154, 0156, 0157, 0167, 0176, 0179, 0180, 0190, 0192, 0198, 0199.	523	699908	Dipstick	584	794682	Cover-Breather Passage (Used After Code Date 07071800). (Use With Liquid Sealant Reference 850)
474D	696458	Alternator (10 To 16 Amp Regulated) Used on Type No(s). 0115, 0165, 0189, 0197.	524	★691032	Seal-Dipstick Tube			
501A	691188	Regulator (5 To 9 Amp Regulated) Used on Type No(s). 0113, 0129, 0133, 0137, 0146, 0154, 0156, 0157, 0167, 0179, 0180, 0192, 0195, 0198, 0199.	525	697184	Tube-Dipstick ----- <b>Note</b> ----- 697085 Tube-Dipstick Used on Type No(s). 0115, 0121, 0122, 0133, 0137, 0139, 0140, 0141, 0142, 0143, 0144, 0145, 0147, 0149, 0150, 0151, 0153, 0154, 0157, 0159, 0161, 0162, 0164, 0165, 0166, 0170, 0173, 0178, 0179, 0185, 0187, 0188, 0189, 0191, 0197, 0199.			----- <b>Note</b> ----- 697112 Cover- Breather Passage (Used Before Code Date 07071900).
501B	698315	Regulator (5 To 9 Amp Regulated) Used on Type No(s). 0176.	526A	697088	Screw (Regulator)(5 To 9 Amp Regulated)	597	691696	Screw (Pawl Friction Plate)
501C	790292	Regulator (Dual Circuit) Used on Type No(s). 0147, 0150.	526B	697348	Screw	601	791850	Clamp-Hose
501D	691185	Regulator (10 To 16 Amp Regulated) Used on Type No(s). 0115, 0165, 0189, 0197.	527	792167	Clamp-Tube	601A	691038	Clamp-Hose
505	691251	Nut (Governor Control Lever)	544	692034	Armature-Starter	608	695058	Starter-Rewind
507	691972	Insulator	552	697144	Bushing-Governor Crank	613	691416	Screw (Muffler)
510	693699	Drive-Starter	559	697561	Screw (Remote Choke Stop) Used on Type No(s). 0142, 0166, 0170, 0185.	613A	691678	Screw (Muffler)
513	692024	Clutch-Drive	559A	693675	Screw (Remote Choke Stop) Used on Type No(s). 0170, 0185.	613B	690297	Screw (Muffler)
520	691084	Terminal-Ground	562	691119	Bolt (Governor Control Lever)	614	691620	Pin-Cotter
521	690581	Shield-Cable Used on Type No(s). 0121, 0122, 0123, 0124, 0125, 0127, 0128, 0172, 0173, 0178, 0186.	578	692306	Wire Assembly	616	692012	Crank-Governor
			579	691029	Nut (Starter Cable)	617	★692138	Seal-O Ring (Intake Manifold)
						621	692310	Switch-Stop Used on Type No(s). 0101, 0105, 0119, 0120, 0134, 0138, 0139, 0140, 0141, 0142, 0144, 0145, 0147, 0149, 0150, 0151, 0154, 0156, 0157, 0159, 0161, 0166, 0168, 0176, 0179, 0180, 0184, 0192, 0195, 0198, 0199.
						633	690597	Seal-Choke/Throttle Shaft Used on Type No(s). 0142, 0166.
						634	●690802	Spring/Seal Assembly (Walbro)
						634A	●698779	Spring/Seal Assembly (Nikki)
						635	691909	Boot-Spark Plug
						643	697155	Retainer-Air Filter
						654	690958	Nut (Carburetor)

★ Included in Engine Gasket Set-Ref. No. 358.

● Included in Carburetor Overhaul Kit-Ref. No. 121 or 121A.

◆ Included in Carburetor Gasket Set-Ref. No. 977 or 977A.

△ Included in Valve Gasket Set-Ref. No. 1095.

**Illustrations cover a range of engines. Parts shown without corresponding text may not be used on your specific engine.**

# 21A900

REF. NO.	PART NO.	DESCRIPTION	REF. NO.	PART NO.	DESCRIPTION	REF. NO.	PART NO.	DESCRIPTION
676	393761	Deflector-Muffler (Side Out) Used on Type No(s). 0101, 0105, 0115, 0117, 0119, 0120, 0121, 0122, 0134, 0136, 0137, 0138, 0139, 0140, 0141, 0142, 0144, 0145, 0147, 0149, 0150, 0151, 0153, 0154, 0157, 0159, 0161, 0162, 0166, 0168, 0172, 0173, 0176, 0179, 0180, 0184, 0185, 0186, 0187, 0188, 0191, 0192, 0195, 0198, 0199.	757	697607	Link-Counterweight	843	697158	Sleeve-Lever Used on Type No(s). 0139, 0140, 0142, 0166.
			758	697391	Counterweight (Used After Code Date 05100200). ----- <b>Note</b> ----- <b>795940</b> Counterweight (Used Before Code Date 05100300). Must Use Kit 795940, Includes Sump And Counterweight. <b>795957</b> Counterweight (Used Before Code Date 05100300). Used on Type No(s). 0101, 0105, 0115, 0119, 0121, 0122, 0129, 0156, 0157, 0165, 0172, 0173, 0176, 0178, 0179, 0180, 0186, 0187, 0188, 0189, 0190, 0191, 0192, 0195, 0197, 0198, 0199. Must Use Kit 795957, Includes Sump And Counterweight.	847	790442	Dipstick/Tube Assembly ----- <b>Note</b> ----- <b>790443</b> Dipstick/Tube Assembly Used on Type No(s). 0115, 0121, 0122, 0133, 0137, 0139, 0140, 0141, 0142, 0143, 0144, 0145, 0147, 0149, 0150, 0151, 0153, 0154, 0157, 0159, 0161, 0162, 0164, 0165, 0166, 0170, 0173, 0178, 0179, 0185, 0187, 0188, 0189, 0191, 0197, 0199.
676A	396903	Deflector-Muffler (Side Out) Used on Type No(s). 0178.	759	697392	Pin-Counterweight	850	100100	Sealant-Liquid (Rocker Cover Gasket and Breather Gasket) (Used After Code Date 07071800).
677	690661	Screw (Muffler Deflector)	783	693713	Gear-Pinion	851	692424	Terminal-Spark Plug
687	697175	Slide-Control Used on Type No(s). 0139, 0140, 0142, 0166.	789	698329	Harness-Wiring	864	697346	Adapter-Muffler
688	690395	Cap-Friction Used on Type No(s). 0139, 0140, 0142, 0166.	789A	790544	Harness-Wiring	868	★△690968	Seal-Valve
689	691855	Spring-Friction	797	693167	Nut (Brush Retainer)	877	393456	Wire/Connector- Alternator (Dual Circuit)
689A	690529	Spring-Friction Used on Type No(s). 0139, 0140, 0142, 0166.	801	691283	Cap-Drive	877A	393814	Wire/Connector- Alternator (DC Only)
691	★692407	Seal-Governor Shaft	802	691286	Cap-End	877B	393537	Wire/Connector- Alternator (5 To 9 Amp Regulated)
692	691301	Spring-Detent	803		Housing-Starter (Not Serviced Separately, Order Starter Motor <b>693551</b> )	877C	399916	Wire/Connector- Alternator (10 To 16 Amp Regulated)
697	690372	Screw (Drive Cap)	823	698941	Screw (Muffler Adapter)			
705	790561	Nut (Fuel Tank)	830	691095	Stud-Rocker Arm			
718	690959	Pin-Locating	832	790293	Guard-Muffler Used on Type No(s). 0147, 0149, 0150, 0151, 0184.			
729	691335	Clip-Wire (Wire Retainer)	836	690367	Screw-Muffler Guard			
729A	691224	Clip-Wire (Starter Motor)	842	★691031	Seal-O Ring (Dipstick Tube)			
729B	694123	Clip-Wire						
741	697128	Gear-Timing						
750	790832	Screw (Oil Pump Cover)						

★ Included in Engine Gasket Set-Ref. No. 358.

● Included in Carburetor Overhaul Kit-Ref. No. 121 or 121A.

◆ Included in Carburetor Gasket Set-Ref. No. 977 or 977A.

△ Included in Valve Gasket Set-Ref. No. 1095.

**Illustrations cover a range of engines. Parts shown without corresponding text may not be used on your specific engine.**



# 21A900

REF. NO.	PART NO.	DESCRIPTION	REF. NO.	PART NO.	DESCRIPTION	REF. NO.	PART NO.	DESCRIPTION
878	398661	Harness-Alternator	968	697420	Cover-Air Cleaner (Black)	1040	698368	Plate-Trim Used on Type No(s). 0104, 0113, 0121, 0122, 0133, 0137, 0140, 0143, 0152, 0155, 0158, 0164, 0167, 0169, 0172, 0173, 0178, 0186.
883	★692236	Gasket-Exhaust			----- <b>Note</b> -----			
884	691956	Clamp-Muffler Used on Type No(s). 0121, 0122, 0173.			697422 Cover-Air Cleaner (Red)			
914	691108	Screw (Rocker Cover)	972	792168	Tank-Fuel (Plastic)	1040A	697381	Plate-Trim Used on Type No(s). 0101, 0105, 0119, 0120, 0129, 0131, 0154, 0156, 0165, 0180, 0183, 0189, 0189, 0192, 0195, 0197, 0198, 0199.
918	791851	Hose-Vacuum (Molded)	975	495933	Bowl-Float (Walbro)			
920	691656	Solenoid-Starter Used on Type No(s). 0147, 0150, 0172, 0186.	975A	698783	Bowl-Float (Nikki)			
943	★690589	Seal-O Ring (Oil Pump Cover)	977	690192	Gasket Set-Carburetor			
950	691657	Screw-Float Bowl (Bottom Of Bowl)	977A	790032	Gasket Set-Carburetor (Nikki)			
957	792647	Cap-Fuel Tank (Plastic)	987	●691326	Seal-Throttle Shaft	1044	698139	Screw (Flywheel)
958	698183	Valve-Fuel Shut Off (Plastic) Used on Type No(s). 0141, 0144, 0146, 0154, 0156, 0157, 0159, 0161, 0167, 0171, 0172, 0179, 0185, 0186, 0190, 0191.	987A	●698777	Seal-Throttle Shaft (Nikki)	1051	691265	Ring-Retaining
965	499613	Cover-Oil Pump	1005	794439	Fan-Flywheel (Used After Code Date 07040800).	1054	280275	Tie-Cable
967	697292	Filter-Pre Cleaner	1005A	794440	Fan-Flywheel (Used Before Code Date 07040900).	1058	276344	Manual-Operator's ----- <b>Note</b> ----- <b>MS3787</b> Manual- Operator's Used on Type No(s). 0101, 0134, 0164, 0165, 0170, 0189, 0197. <b>MS3788</b> Manual- Operator's Used on Type No(s). 0105, 0191.
			1005B		Fan-Flywheel (No Longer Available) (See Reference1005A For Service Flywheel Fan).	1059	698516	Kit-Screw/Washer
			1017	690770	Screen-Oil Pump	1070	690372	Screw (Flywheel Fan) (Used Before Code Date 07040900).
			1022★△272475S		Gasket-Rocker Cover (Used Before Code Date 07091000). (After Date Code Use liquid Sealant Reference 850)	1070A	690363	Screw (Flywheel Fan) (Used After Code Date 07040800).
			1023	794659	Cover-Rocker	1090	691293	Retainer-Brush
			1024	499054	Pump-Oil (Used Before Code Date 07051700).	1091	691333	Cap-Limiter
			1024A	794644	Pump-Oil (Used After Code Date 07051600).	1095	691581	Gasket Set-Valve
			1026	697395	Rod-Push (Exhaust) ----- <b>Note</b> ----- 697394 Rod-Push (Intake)	1119	691183	Screw (Alternator)
			1027	492932S	Filter-Oil	1127	695407	Screw (Float Bowl)
			1029	691751	Arm-Rocker	1136	690278	Screw (Control Bracket)(High Speed Control) Used on Type No(s). 0139, 0140, 0142, 0166.
			1034	690822	Guide-Push Rod	1146	793380	Screw (Choke Shaft)(Manual Choke)
			1036		Label-Emissions (Available From A Briggs & Stratton Authorized Dealer)			

★ Included in Engine Gasket Set-Ref. No. 358.

● Included in Carburetor Overhaul Kit-Ref. No. 121 or 121A.

◆ Included in Carburetor Gasket Set-Ref. No. 977 or 977A.

△ Included in Valve Gasket Set-Ref. No. 1095.

**Illustrations cover a range of engines. Parts shown without corresponding text may not be used on your specific engine.**

# 21A900

REF. NO.	PART NO.	DESCRIPTION	REF. NO.	PART NO.	DESCRIPTION	REF. NO.	PART NO.	DESCRIPTION
1263	697124	Reed-Breather	1267	697419	Latch-Blower Housing (Black)	1270	697156	Plug-AVS Counterweight
1264	697104	Screw (Breather Reed)			----- <b>Note</b> -----	1319	794467	Label-Warning
1266	★●691917	Seal-O Ring (Intake Elbow)		697424	Latch-Blower Housing (Red)	1397	791219	Washer (Blower Housing)
1266A	★●697123	Seal-O Ring (Intake Elbow)						

★ Included in Engine Gasket Set-Ref. No. 358.

● Included in Carburetor Overhaul Kit-Ref. No. 121 or 121A.

◆ Included in Carburetor Gasket Set-Ref. No. 977 or 977A.

△ Included in Valve Gasket Set-Ref. No. 1095.

**Illustrations cover a range of engines. Parts shown without corresponding text may not be used on your specific engine.**